

LC503AYL1-15P-A

Features

5mm Package
 High Luminous Intensity
 High Optical Power
 All Plastic Mold Type
 Water Clear Lens
 LEAD FREE

Applications

Decorative Lighting
 General Purpose Lighting
 Indoor Message Centers
 Instrumentation
 Medical Equipment



ATTENTION

OBSERVE PRECAUTIONS
 ELECTROSTATIC
 SENSITIVE DEVICES

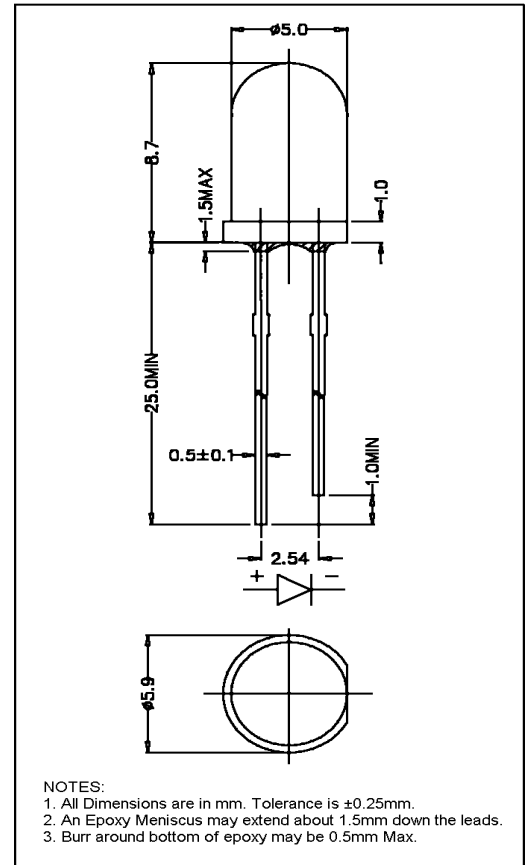

Maximum Ratings (Ta=25°C)

Characteristic	Symbol	Max.	Unit
Forward Current	I _F	50	mA
Reverse Voltage	V _R	5	V
Power Dissipation	P _D	130.00	mW
Operating Temperature	T _{opr}	-40 ~ +95	°C
Storage Temperature	T _{stg}	-40 ~ +100	°C
Soldering Temperature	T _{sol}	260	°C
Soldering Time	-	for 3 sec. max	-

Opto-Electrical Characteristics (Ta=25°C)

Characteristic	Symbol	Test Condition	Min	Typ	Max	Unit
Forward Voltage	V _F	I _F =20mA	-	2.10	2.60	V
Reverse Current	I _R	V _R =5V	-	-	100	μA
Luminous Intensity	I _v	I _F =20mA	8200.00	16000.00	-	mcd
Viewing Angle	2θ ^{1/2}	-	-	15°	-	deg.
Peak Wavelength	λ _p	I _F =20mA	-	594	-	nm
Dominant Wavelength	λ _d	I _F =20mA	-	591	-	nm
Spectral Line Half Width	Δλ	I _F =20mA	-	20	-	nm

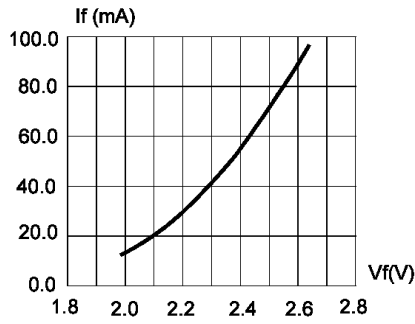

FIG.1 FORWARD CURRENT VS. FORWARD VOLTAGE.

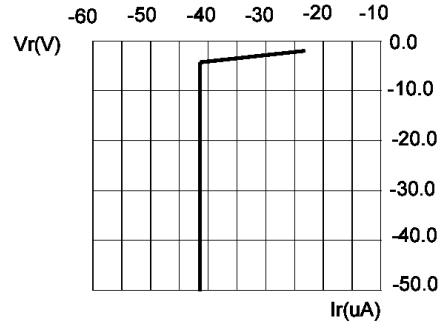

FIG.2 REVERSE CURRENT VS. REVERSE VOLTAGE.

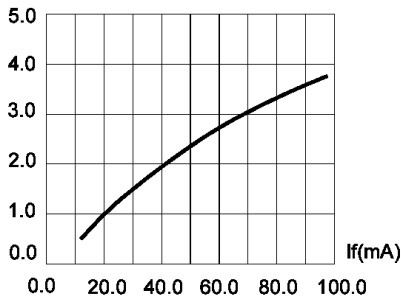

FIG.3 RELATIVE LUMINOUS INTENSITY VS. FORWARD CURRENT.

Half Power Δ WL=20nm
Domi WL= 591nm

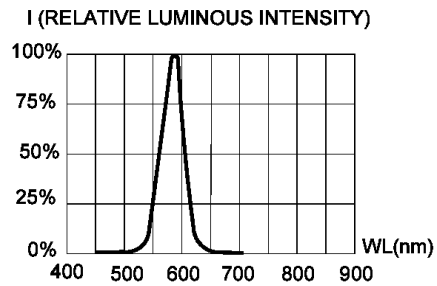

FIG.4 RELATIVE LUMINOUS INTENSITY VS. WAVELENGTH.

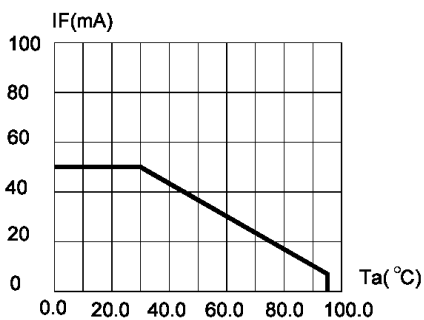

FIG.5 MAXIMUM FORWARD DC CURRENT VS AMBIENT TEMPERATURE ($T_{jmax}=105^{\circ}$ C)

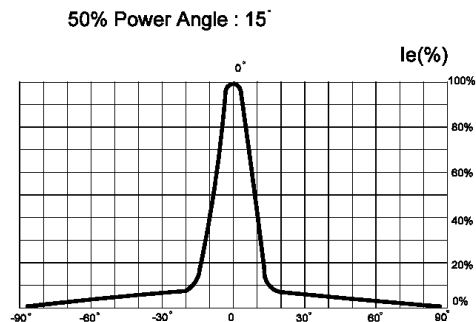

FIG.6 FAR FIELD PATTERN